

CIS Degree Planning and Tracking Chart

2015-16
03/6/2015

- 1 - Oral and Written Communication, and Quantitative Literacy courses must be completed **prior** to business core courses.
- 2 - Total unrestricted electives must be sufficient to meet the University's minimum required 120 credit hours.
- 3 - To enroll, pass the CIS2010 proficiency test or take CIS/CSS1010 during your **Freshman** year.
- 4 - PHI3360 is the preferred course.
- 5 - All Business Core courses must be completed **prior** to MGT4950.

- A Multicultural Course must be taken as an elective or General Studies course.
- At least 40 of the 120 credit hours must be taken as **upper division** courses.

General Studies

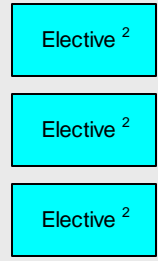
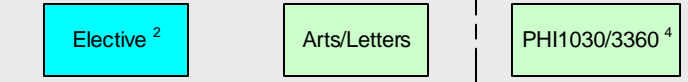
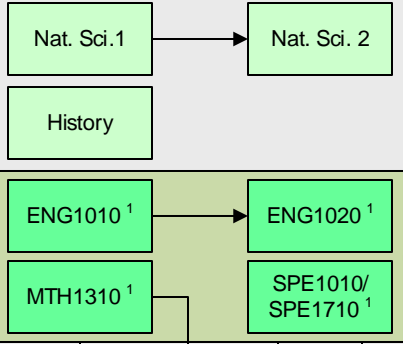

College of Business Requirements

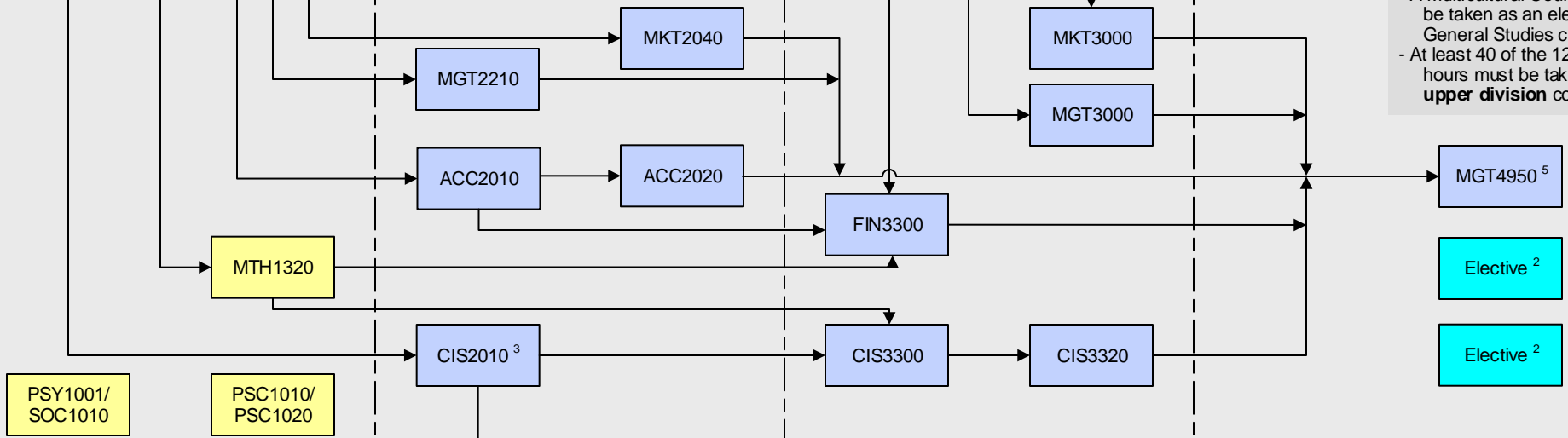

CIS Major Requirements

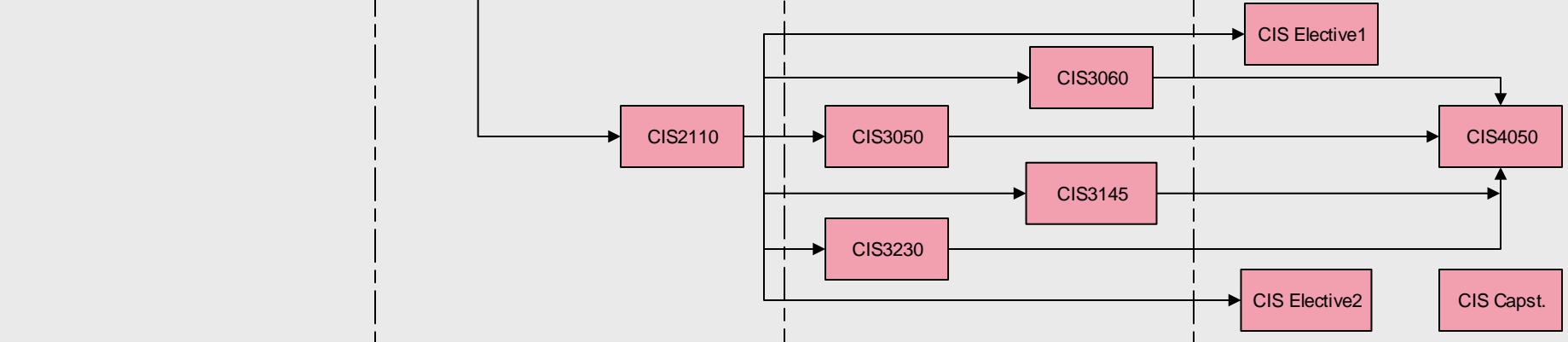

Freshman year

Sophomore year

Junior year

Senior year